

HORTUM RAKORLARI ve SOKETLER

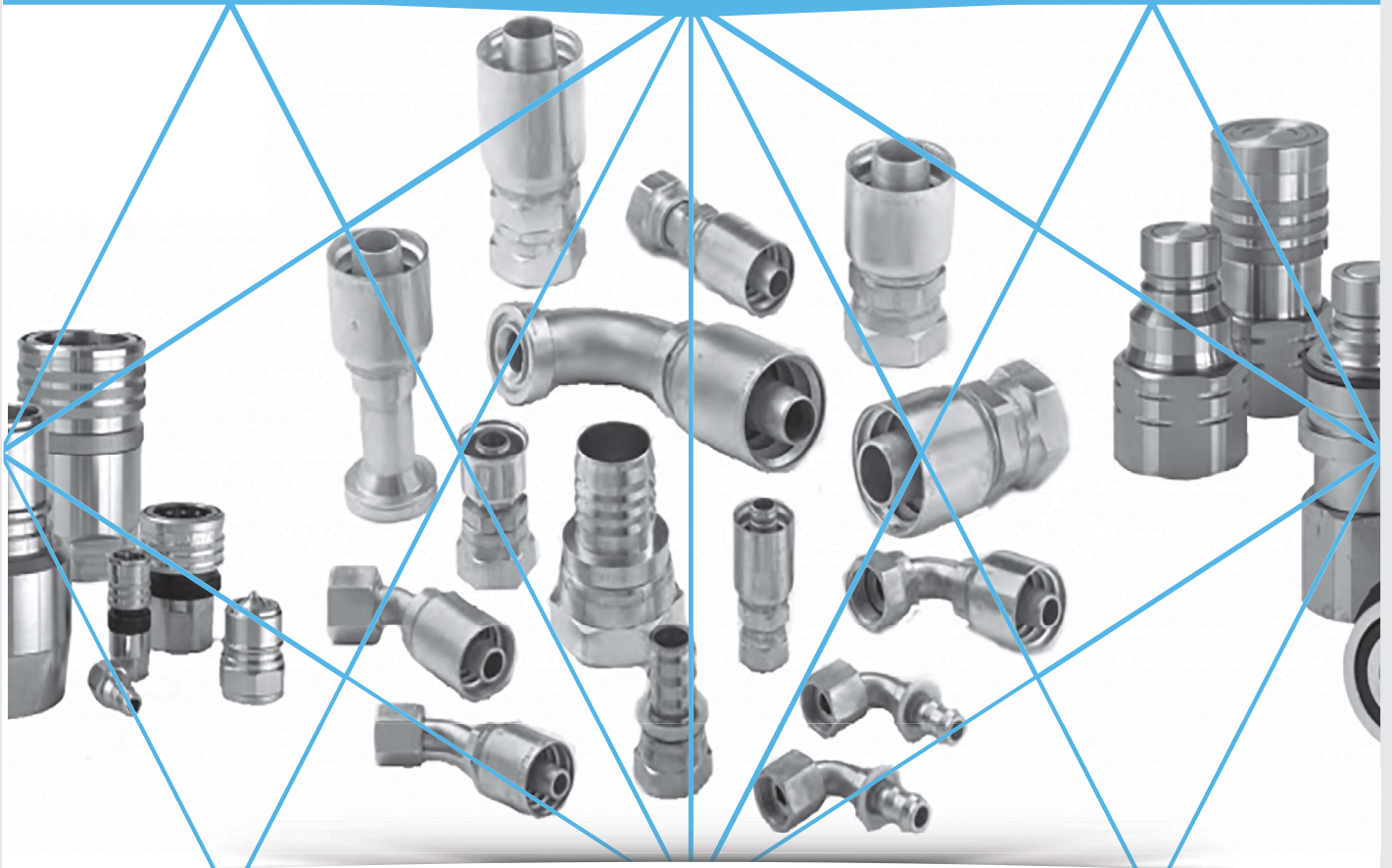

DÜZ ERKEK METRİK L SERİSİ HORTUM RAKORU

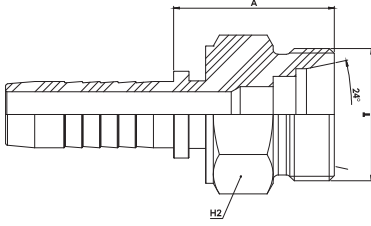

MALZEME KODU	HORTUM İÇ ÇAPI		DİŞ ÖLÇÜSÜ	BOYUTSAL ÖLÇÜLER		
	DN	İNCH	T	PIPE	A	H2
001595	5	3/16"	M 12x1,5	6L	20,4	12
001734	6	1/4"	M 12x1,5	6L	21	12
001735	6	1/4"	M 14x1,5	8L	23,5	14
001736	6	1/4"	M 16x1,5	10L	25,5	17
001737	6	1/4"	M 18x1,5	12L	26,5	19
001874	8	5/16"	M 14x1,5	8L	23,5	14
001875	8	5/16"	M 16x1,5	10L	25	17
001876	8	5/16"	M 18x1,5	12L	27,5	19
002047	10	3/8"	M 16x1,5	10L	27	17
002048	10	3/8"	M 18x1,5	12L	27	19
002049	10	3/8"	M 22x1,5	15L	27,5	22
002238	12	1/2"	M 18x1,5	12L	27	19
002239	12	1/2"	M 22x1,5	15L	32	22
002240	16	1/2"	M 26x1,5	18L	31,5	27
002420	16	5/8"	M 26x1,5	18L	34	27
002421	16	5/8"	M 30x2	22L	37,5	32
002604	19	3/4"	M 30x2	22L	36,5	32
002605	19	3/4"	M 36x2	28L	41	41
002861	25	1"	M 36x2	28L	41	41
002862	25	1"	M 45x2	35L	48	50
003136	31	1.1/4"	M45x2	35L	48,8	50
003138	31	1.1/4"	M 52x2	42L	45,5	55
003361	38	1.1/2"	M 52x2	42L	46	55

DÜZ SOMUNLU METRİK L SERİSİ HORTUM RAKORU

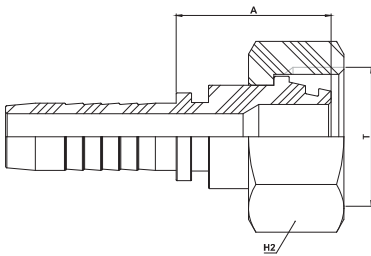

MALZEME KODU	HORTUM İÇ ÇAPI		DİŞ ÖLÇÜSÜ	BOYUTSAL ÖLÇÜLER		
	DN	İNCH	T	PIPE	A	H2
001555	5	3/16"	M 12x1,5	6L	20,3	14
* 001621	6	1/4"	M 12x1,5	6L	21,8	17
001622	6	1/4"	M 14x1,5	8L	24,5	17
001623	6	1/4"	M 16x1,5	10L	22,7	19
001624	6	1/4"	M 18x1,5	12L	24,5	22
* 001794	8	5/16"	M 14x1,5	8L	23,2	17
001795	8	5/16"	M 16x1,5	10L	23,7	19
001796	8	5/16"	M 18x1,5	12L	24,7	22
* 001930	10	3/8"	M 16x1,5	10L	22	22
001931	10	3/8"	M 18x1,5	12L	25,5	22
001932	10	3/8"	M 22x1,5	15L	27	27
* 002123	12	1/2"	M 18x1,5	12L	29,2	22
002124	12	1/2"	M 22x1,5	15L	25,5	27
002125	12	1/2"	M 26x1,5	18L	30	32
002346	16	5/8"	M 26x1,5	18L	32	32
002347	16	5/8"	M 30x2	22L	32	36
002504	19	3/4"	M 30x2	22L	30,5	36
002505	19	3/4"	M 36x2	28L	38,5	41
002738	25	1"	M 36x2	28L	40	41
002739	25	1"	M 45x2	35L	40	50
003019	31	1.1/4"	M45x2	35L	45,2	50
003021	31	1.1/4"	M 52x2	42L	47,5	60
003288	38	1.1/2"	M 52x2	42L	46,5	60

* Etek sıkmalı hortum rakorları

90°S METRİK L SERİSİ HORTUM RAKORU

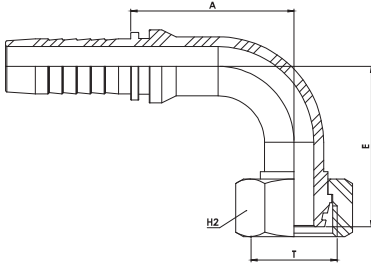

MALZEME KODU	HORTUM İÇ ÇAPI		DIŞ ÖLÇÜSÜ		BOYUTSAL ÖLÇÜLER		
	DN	İNCH	T	PİPE	E	A	H2
001584	5	3/16	M 12x1,5	6L	30	26	14
* 001699	6	1/4"	M 12x1,5	6L	35	28	17
001700	6	1/4"	M 14x1,5	8L	32,5	34	17
001701	6	1/4"	M 16x1,5	10L	35	33	19
001702	6	1/4"	M 16x1,5	12L	36	33	22
* 001847	8	5/16"	M 14x1,5	8L	33	33	17
001848	8	5/16"	M 16x1,5	10L	39,5	32,5	19
001849	8	5/16"	M 18x1,5	12L	40	32	22
* 002007	10	3/8"	M 16x1,5	10L	42,5	37,5	22
002008	10	3/8"	M 18x1,5	12L	33	39	22
002009	10	3/8"	M 22x1,5	15L	37	39	27
* 002200	12	1/2"	M 18x1,5	12L	49	46	22
002201	12	1/2"	M 22x1,5	15L	39	40	27
002202	12	1/2"	M 26x1,5	18L	50	45,5	32
002396	16	5/8"	M 26x1,5	18L	55	55	32
002397	16	5/8"	M 30x2	22L	57	53	36
002574	19	3/4"	M 30x2	22L	57	58	36
002575	19	3/4"	M 36x2	28L	68	65	41
002826	25	1"	M 36x2	28L	71	82	41
002827	25	1"	M 45x2	35L	72	78	50
003106	31	1.1/4"	M 45x2	35L	80	91	50
003108	31	1.1/4"	M 52x2	42L	89	87	60
003340	38	1.1/2"	M 52x2	42L	99,5	95	60

45°S METRİK L SERİSİ HORTUM RAKORU

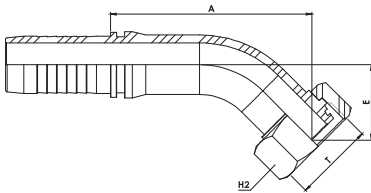

MALZEME KODU	HORTUM İÇ ÇAPI		DIŞ ÖLÇÜSÜ		BOYUTSAL ÖLÇÜLER		
	DN	İNCH	T	PİPE	E	A	AA
001573	5	3/16"	M 12x1,5	6L	16	35	14
001664	6	1/4"	M 12x1,5	6L	20	40,5	17
001665	6	1/4"	M 14x1,5	8L	20	42,5	17
001666	6	1/4"	M 16x1,5	10L	23	43,5	19
001667	6	1/4"	M 18x1,5	12L	22,5	45,5	22
* 001822	8	5/16"	M 14x1,5	8L	20	44,5	17
001823	8	5/16"	M 16x1,5	10L	23	44,5	19
001824	8	5/16"	M 18x1,5	12L	19,5	46	22
* 001971	10	3/8"	M 16x1,5	10L	23,5	51	22
001972	10	3/8"	M 18x1,5	12L	20	45	22
001973	10	3/8"	M 22x1,5	15L	28	57	27
* 002167	12	1/2"	M 18x1,5	12L	32	70	22
002168	12	1/2"	M 22x1,5	15L	25	60	27
002169	12	1/2"	M 26x1,5	18L	27	63	32
002374	16	5/8"	M 26x1,5	18L	27	70	32
002375	16	5/8"	M 30x2	22L	29	78	36
002538	19	3/4"	M 30x2	22L	24	86	36
002539	19	3/4"	M 36x2	28L	37,5	82	41
002782	25	1"	M 36x2	28L	41,5	104	41
002783	25	1"	M 45x2	35L	40	101	50
003070	31	1.1/4"	M 45x2	35L	43	115	50
003071	31	1.1/4"	M 52x2	42L	53,5	119,5	60
003317	38	1.1/2"	M 52x2	42L	54	120	60

DE METRİK S SERİSİ HORTUM RAKORU

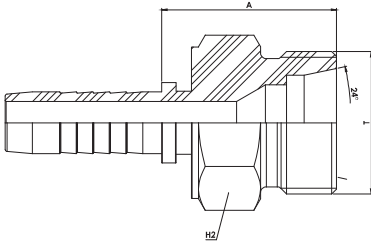

MALZEME KODU	HORTUM İÇ ÇAPı		DİŞ ÖLÇÜSÜ	BOYUTSAL ÖLÇÜLER		
	DN	İNCH	T	PİPE	A	H2
001738	6	1/4"	M 14x1,5	6S	23,5	14
001739	6	1/4"	M 16x1,5	8S	25,5	17
001740	6	1/4"	M 18x1,5	10S	27	19
001741	6	1/4"	M 20x1,5	12S	27,8	22
044868	8	5/16"	M 14x1,5	6S	23,4	14
001877	8	5/16"	M 16x1,5	8S	25	17
001878	8	5/16"	M 18x1,5	10S	27,3	19
001879	8	5/16"	M 20x1,5	12S	28,5	22
044898	10	3/8"	M 16x1,5	8S	27	17
002050	10	3/8"	M 18x1,5	10S	28	19
002051	10	3/8"	M 20x1,5	12S	27	22
002053	10	3/8"	M 24x1,5	16S	30	24
002241	12	1/2"	M 20x1,5	12S	28	22
002243	12	1/2"	M 24x1,5	16S	30	24
002244	12	1/2"	M 30x2	20S	36,8	32
002423	16	5/8"	M 30x2	20S	37,5	32
002609	19	3/4"	M 30x2	20S	36,5	32
002610	19	3/4"	M 36x2	25S	42	41
002866	25	1"	M 36x2	25S	41	41
002867	25	1"	M 42x2	30S	44,5	46
003141	31	1.1/4"	M 42x2	30S	43,5	46
003142	31	1.1/4"	M 52x2	38S	45,5	55
003363	38	1.1/2"	M 52x2	38S	45,5	55

DS METRİK S SERİSİ HORTUM RAKORU

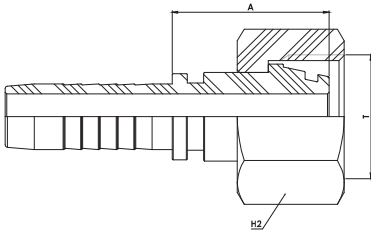

MALZEME KODU	HORTUM İÇ ÇAPı		DİŞ ÖLÇÜSÜ	BOYUTSAL ÖLÇÜLER		
	DN	İNCH	T	PİPE	A	H2
001625	6	1/4"	M 14x1,5	6S	24,4	17
001626	6	1/4"	M 16x1,5	8S	22,7	19
001627	6	1/4"	M 18x1,5	10S	25,1	22
001628	6	1/4"	M 20x1,5	12S	27,2	24
* 044894	8	5/16"	M 14x1,5	6S	23,2	17
* 001797	8	5/16"	M 16x1,5	8S	24	19
* 001798	8	5/16"	M 18x1,5	10S	25,1	22
001799	8	5/16"	M 20x1,5	12S	27,2	24
* 001933	10	3/8"	M 16x1,5	8S	25,5	22
* 001934	10	3/8"	M 18x1,5	10S	24,5	22
001935	10	3/8"	M 20x1,5	12S	28	24
001937	10	3/8"	M 24x1,5	16S	28	30
* 002128	12	1/2"	M 20x1,5	12S	29	24
002130	12	1/2"	M 24x1,5	16S	31	30
002131	12	1/2"	M 30x2	20S	30,8	36
002350	16	5/8"	M 30x2	20S	35,5	36
* 002507	19	3/4"	M 30x2	20S	34,7	36
045081	19	3/4"	M 36x2	25S	37,5	41
* 045082	25	1"	M 36x2	25S	39	41
002744	25	1"	M 42x2	30S	39,9	50
* 003024	31	1.1/4"	M 42x2	30S	43	50
003026	31	1.1/4"	M 52x2	38S	46,5	60
003292	38	1.1/2"	M 52x2	38S	43	60

90 METRİK S SERİSİ HORTUM RAKORU

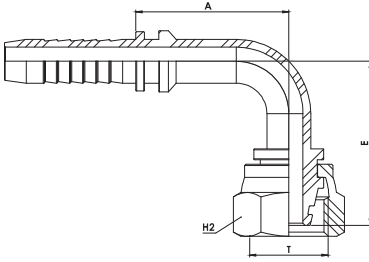

MALZEME KODU	HORTUM İÇ ÇAPI		DİŞ ÖLÇÜSÜ	BOYUTSAL ÖLÇÜLER			
	DN	İNCH	T	PİPE	E	A	H2
001703	6	1/4"	M 14x1,5	6S	32,5	34	17
001704	6	1/4"	M 16x1,5	8S	35	33	19
001705	6	1/4"	M 18x1,5	10S	36	33	22
001706	6	1/4"	M 20x1,5	12S	40	28	24
* 044897	8	5/16"	M 14x1,5	6S	34,5	29	17
* 001850	8	5/16"	M 16x1,5	8S	39,5	32,5	19
* 001851	8	5/16"	M 18x1,5	10S	40	32	22
001852	8	5/16"	M 20x1,5	12S	38	28	24
* 002010	10	3/8"	M 16x1,5	8S	42,5	37,5	22
* 002011	10	3/8"	M 18x1,5	10S	33	39	22
002012	10	3/8"	M 20x1,5	12S	33	39	24
002014	10	3/8"	M 24x1,5	16S	44	36,5	30
* 002204	12	1/2"	M 20x1,5	12S	38,5	50	24
002206	12	1/2"	M 24x1,5	16S	39	48	30
002207	12	1/2"	M 30x2	20S	52	50	36
002399	16	5/8"	M 30x2	20S	57	53	36
* 002577	19	3/4"	M 30x2	20S	62	52,5	36
045086	19	3/4"	M 36x2	25S	68	65	41
* 045087	25	1"	M 36x2	25S	71	82	41
002832	25	1"	M 42x2	30S	77	73	50
* 003111	32	1.1/4"	M42x2	30S	80	90	50
003112	32	1.1/4"	M52x2	38S	89	87	60
003342	38	1.1/2"	M 52x2	38S	99,5	95	60

45 METRİK S SERİSİ HORTUM RAKORU

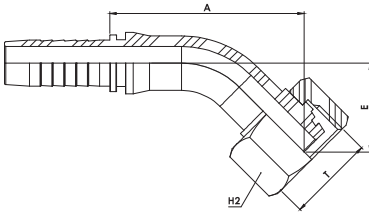

MALZEME KODU	HORTUM İÇ ÇAPI		DİŞ ÖLÇÜSÜ	BOYUTSAL ÖLÇÜLER			
	DN	İNCH	T	PİPE	E	A	H2
001668	6	1/4"	M 14x1,5	6S	20	42,5	17
001669	6	1/4"	M 16x1,5	8S	23	43,5	19
001670	6	1/4"	M 18x1,5	10S	22,5	45,5	22
001671	6	1/4"	M 20x1,5	12S	22	46,5	24
* 044895	8	5/16"	M 14x1,5	6S	20	44,5	19
001825	8	5/16"	M 16x1,5	8S	23	44,5	19
* 001826	8	5/16"	M 18x1,5	10S	19,5	46	22
001827	8	5/16"	M 20x1,5	12S	24,5	47	24
* 044899	10	3/8"	M 16x1,5	8S	23,5	57	22
* 001975	10	3/8"	M 18x1,5	10S	20	45	22
001976	10	3/8"	M 20x1,5	12S	20	45	24
001978	10	3/8"	M 24x1,5	16S	27,5	53	30
* 044900	12	1/2"	M 20x1,5	12S	34	66	24
044901	12	1/2"	M 24x1,5	16S	30	60	30
002173	12	1/2"	M 30x2	20S	40	60	36
002377	16	5/8"	M 30x2	20S	29	78	36
002541	19	3/4"	M 30x2	20S	40	87	36
045088	19	3/4"	M 36x2	25S	37,5	82	41
* 045089	25	1"	M 36x2	25S	41,5	104	41
002786	25	1"	M 42x2	30S	37,5	103	50
* 003073	31	1.1/4"	M 42x2	30S	52	121	50
003074	31	1.1/4"	M 52x2	38S	53,5	119,5	60
003318	38	1.1/2"	M 52x2	38S	54	120	60

DE BSP 60° HORTUM RAKORU

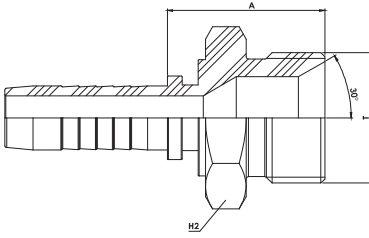

MALZEME KODU	HORTUM İÇ ÇAPI		DIŞ ÖLÇÜSÜ T	BOYUTSAL ÖLÇÜLER	
	DN	İNCH		A	H2
001751	6	1/4"	1/4" -19	25,5	17
001752	6	1/4"	3/8" -19	28	22
001886	8	5/16"	1/4" -19	25,5	17
001887	8	5/16"	3/8" -19	28	22
001888	8	5/16"	1/2" -14	34	27
002064	10	3/8"	3/8" -19	28,5	22
002065	10	3/8"	1/2" -14	32	27
002256	12	1/2"	3/8" -19	27	22
002257	12	1/2"	1/2" -14	33	27
002258	12	1/2"	5/8" -14	32	27
002259	12	1/2"	3/4" -14	32	32
002429	16	5/8"	1/2" -14	32	27
002430	16	5/8"	5/8" -14	32	27
002431	16	5/8"	3/4" -14	37	32
002620	19	3/4"	3/4" -14	37,5	32
002621	19	3/4"	1" -11	41,5	41
002875	25	1"	1" -11	42	41
002876	25	1"	1 1/4" -11	44,5	46
003147	31	1.1/4"	1 1/4" -11	46	46
003368	38	1.1/2"	1 1/2" -11	48	55
003470	51	2"	2" -11	58	65

DS BSP HORTUM RAKORU

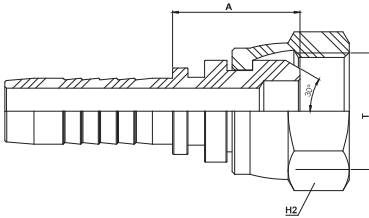

MALZEME KODU	HORTUM İÇ ÇAPI		DIŞ ÖLÇÜSÜ T	BOYUTSAL ÖLÇÜLER	
	DN	İNCH		A	H2
* 001566	5	3/16"	1/8" -28	16	14
* 001637	6	1/4"	1/8" -28	16	14
* 001638	6	1/4"	1/4" -19	21,5	19
001639	6	1/4"	3/8" -19	25,5	22
* 001640	6	1/4"	1/2" -14	29	27
001806	8	5/16"	1/4" -19	20,5	19
* 001807	8	5/16"	3/8" -19	24,5	22
* 001808	8	5/16"	1/2" -14	28	27
* 001948	10	3/8"	3/8" -19	25	22
* 001949	10	3/8"	1/2" -14	25,5	27
* 002142	12	1/2"	3/8" -19	25	22
* 002143	12	1/2"	1/2" -14	25	27
* 002144	12	1/2"	5/8" -14	25	27
* 002145	12	1/2"	3/4" -14	29	32
* 002356	16	5/8"	1/2" -14	28,5	27
* 002357	16	5/8"	5/8" -14	27	27
* 002358	16	5/8"	3/4" -14	29,5	32
* 002519	19	3/4"	3/4" -14	30,5	32
* 002520	19	3/4"	1" -11	34,5	41
* 045095	25	1"	1" -11	36,5	41
* 002754	25	1"	1 1/4" -11	38	50
* 003033	31	1.1/4"	1 1/4" -11	39,5	50
* 045096	38	1.1/2"	1 1/2" -11	38,5	55
045097	51	2"	2" -11	41	70

90°S BSP HORTUM RAKORU

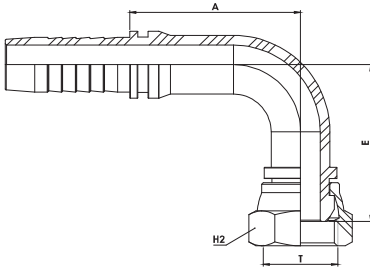

MALZEME KODU	HORTUM İÇ ÇAPU		DİŞ ÖLÇÜSÜ	BOYUTSAL ÖLÇÜLER		
	DN	İNCH	T	E	A	H2
* 001591	5	3/16"	1/8" -28	30	32	14
* 001715	6	1/4"	1/8" -28	32	35,5	14
* 001716	6	1/4"	1/4" -19	32	34,5	19
001717	6	1/4"	3/8" -19	37	33,5	22
* 001718	6	1/4"	1/2" -14	39	41,5	27
* 001859	8	5/16"	1/4" -19	34,5	34	19
001860	8	5/16"	3/8" -19	37	34,5	22
* 001861	8	5/16"	1/2" -14	39	42	27
* 002025	10	3/8"	3/8" -19	33	37	22
* 002026	10	3/8"	1/2" -14	36,5	40,5	27
* 002218	12	1/2"	3/8" -19	43	50	22
* 002219	12	1/2"	1/2" -14	41	42,5	27
* 002220	12	1/2"	5/8" -14	49,5	54	27
* 002221	12	1/2"	3/4" -14	51	54	32
* 002405	16	5/8"	1/2" -14	55	48	27
* 002406	16	5/8"	5/8" -14	54,5	51,5	27
* 002407	16	5/8"	3/4" -14	58,5	56	32
* 002588	19	3/4"	3/4" -14	56	61	32
* 002589	19	3/4"	1" -11	73,5	61	41
* 045091	25	1"	1" -11	75	78,5	41
* 002842	25	1"	1 1/4" -11	90	73	50
* 003117	31	1.1/4"	1 1/4" -11	84	95	50
* 045092	38	1.1/2"	1 1/2" -11	91,5	103	55
* 003464	51	2"	2" -11	124,5	129	70

45°S BSP HORTUM RAKORU

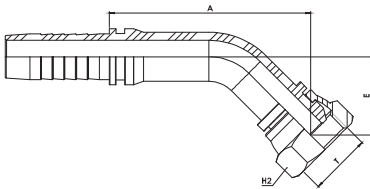

MALZEME KODU	HORTUM İÇ ÇAPU		DİŞ ÖLÇÜSÜ	BOYUTSAL ÖLÇÜLER		
	DN	İNCH	T	E	A	H2
* 001580	5	3/16"	1/8" -28	14	42	14
* 001680	6	1/4"	1/8" -28	24,5	46,5	14
* 001681	6	1/4"	1/4" -19	19	47	19
001682	6	1/4"	3/8" -19	20	43,5	22
* 001683	6	1/4"	1/2" -14	22	55	27
* 001834	8	5/16"	1/4" -19	27	49,5	19
001835	8	5/16"	3/8" -19	18	46	22
* 001836	8	5/16"	1/2" -14	22	53	27
* 001989	10	3/8"	3/8" -19	20	45	22
* 001990	10	3/8"	1/2" -14	18,5	55	27
* 002184	12	1/2"	3/8" -19	29	64,5	22
* 002185	12	1/2"	1/2" -14	21,5	59	27
002186	12	1/2"	5/8" -14	25	72	27
* 002187	12	1/2"	3/4" -14	28	69	32
* 002383	16	5/8"	1/2" -14	32	75	27
* 002384	16	5/8"	5/8" -14	26,5	74	27
* 002385	16	5/8"	3/4" -14	32,5	83,5	32
* 002551	19	3/4"	3/4" -14	33,5	86	32
* 002552	19	3/4"	1" -11	40,5	93	41
* 045093	25	1"	1" -11	39	104	41
* 002796	25	1"	1 1/4" -11	42	112,5	50
* 003078	31	1.1/4"	1 1/4" -11	41,5	117,5	50
* 045094	38	1.1/2"	1 1/2" -11	47,5	119	55
* 003459	51	2"	2" -11	75	175	70

DE UNF HORTUM RAKORU

MALZEME KODU	HORTUM İÇ ÇAPI		DIŞ ÖLÇÜSÜ	BOYUTSAL ÖLÇÜLER	
	DN	İNCH		A	H2
001762	6	1/4"	7/16" -20	24,2	12
001763	6	1/4"	1/2" -20	28,2	14
001764	6	1/4"	9/16" -18	31	17
001894	8	5/16"	1/2" -20	28	14
001895	8	5/16"	9/16" -18	29	17
001896	8	5/16"	5/8" -18	30	17
045078	8	5/16"	3/4" -16	34,5	19
002074	10	3/8"	9/16" -18	31	17
002075	10	3/8"	5/8" -18	30	17
002076	10	3/8"	3/4" -16	36	19
002077	10	3/8"	7/8" -14	35	22
002270	12	1/2"	3/4" -16	36,5	19
002271	12	1/2"	7/8" -14	38,5	22
002272	12	1/2"	1 1/16" -12	43	32
002440	16	5/8"	7/8" -14	40	24
002441	16	5/8"	1 1/16" -12	44	32
002630	19	3/4"	1 1/16" -12	46	32
002883	25	1"	1 1/16" -12	47,5	32
002885	25	1"	1 5/16" -12	48	36
002886	25	1"	1 5/8" -12	54	46
003153	31	1.1/4"	1 5/8" -12	55	46
003371	38	1.1/2"	1 7/8" -12	54,5	50
003473	51	2"	2 1/2" -12	60	70

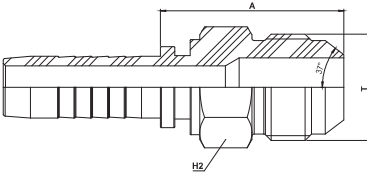

DS UNF HORTUM RAKORU

MALZEME KODU	HORTUM İÇ ÇAPI		DIŞ ÖLÇÜSÜ	BOYUTSAL ÖLÇÜLER	
	DN	İNCH		A	H2
* 001570	5	3/16"	7/16" -20	18	14
* 001647	6	1/4"	7/16" -20	20	17
* 001648	6	1/4"	1/2" -20	18,5	17
* 001649	6	1/4"	9/16" -18	21	19
* 001813	8	5/16"	1/2" -20	23,7	17
* 001814	8	5/16"	9/16" -18	21,5	19
* 001815	8	5/16"	5/8" -18	22,5	22
* 001816	8	5/16"	3/4" -16	24	24
* 001957	10	3/8"	9/16" -18	20,5	19
* 001958	10	3/8"	5/8" -18	20	22
* 001959	10	3/8"	3/4" -16	21,5	24
* 001960	10	3/8"	7/8" -14	22,5	27
* 002152	12	1/2"	3/4" -16	23	24
* 002153	12	1/2"	7/8" -14	21,5	27
* 002154	12	1/2"	1 1/16" -12	30	32
* 002364	16	5/8"	7/8" -14	22	27
* 002365	16	5/8"	1 1/16" -12	27,5	32
* 002527	19	3/4"	1 1/16" -12	26	32
* 002529	19	3/4"	1 5/16" -12	31,5	41
* 002759	25	1"	1 1/16" -12	34	32
* 002761	25	1"	1 5/16" -12	33	41
* 002762	25	1"	1 5/8" -12	38,5	50
* 003040	31	1.1/4"	1 5/8" -12	36,5	50
* 003303	38	1.1/2"	1 7/8" -12	35,5	55
* 003455	51	2"	2 1/2" -12	50	70

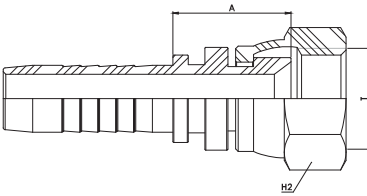

90°S UNF HORTUM RAKORU

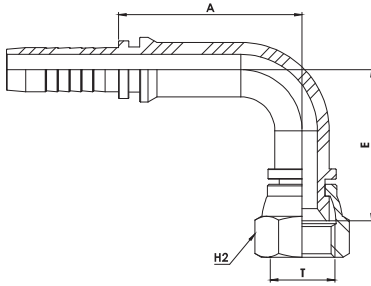

MALZEME KODU	HORTUM İÇ ÇAPDI		DIŞ ÖLÇÜSÜ	BOYUTSAL ÖLÇÜLER		
	DN	İNCH		T	E	A
* 001593	5	3/16"	7/16" -20	32	34	14
* 001724	6	1/4"	7/16" -20	34,5	37	17
* 001725	6	1/4"	1/2" -20	33	34,5	17
* 001726	6	1/4"	9/16" -18	36	32	19
* 001865	8	5/16"	1/2" -20	33	34,5	17
* 001866	8	5/16"	9/16" -18	35	35	19
* 001867	8	5/16"	5/8" -18	38	35	22
* 046184	8	5/16"	3/4" -16	38	33	24
* 002032	10	3/8"	9/16" -18	37	40	19
* 002033	10	3/8"	5/8" -18	38	39	22
* 002034	10	3/8"	3/4" -16	37	40,5	24
* 002035	10	3/8"	7/8" -14	39	40	27
* 002227	12	1/2"	3/4" -16	44,5	54	24
* 002228	12	1/2"	7/8" -14	43	50,5	27
* 002229	12	1/2"	1 1/16" -12	50	55	32
* 002410	16	5/8"	7/8" -14	52	52	27
* 002412	16	5/8"	1 1/16" -12	56	60	32
* 002595	19	3/4"	1 1/16" -12	57,5	61	32
* 002597	19	3/4"	1 5/16" -12	68,5	66,5	41
* 002845	25	1"	1 1/16" -12	55	60	32
* 002847	25	1"	1 5/16" -12	72,5	84	41
* 003122	31	1.1/4"	1 5/8" -12	87	92	50
* 003350	38	1.1/2"	1 7/8" -12	96	99,5	55
* 003466	51	2"	2 1/2" -12	130	130	70

45°S UNF HORTUM RAKORU

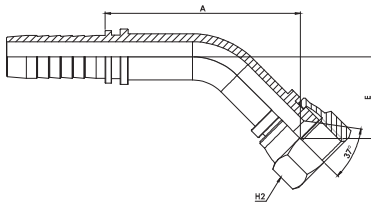

MALZEME KODU	HORTUM İÇ ÇAPDI		DIŞ ÖLÇÜSÜ	BOYUTSAL ÖLÇÜLER		
	DN	İNCH		T	E	A
* 001582	5	3/16"	7/16" -20	18	45	14
* 001689	6	1/4"	7/16" -20	20	49,5	17
* 001690	6	1/4"	1/2" -20	19	45,5	17
* 001691	6	1/4"	9/16" -18	22	46	19
* 001839	8	5/16"	1/2" -20	19	45,5	17
* 001840	8	5/16"	9/16" -18	18,5	45	19
* 001841	8	5/16"	5/8" -18	23	50,5	22
* 045080	8	5/16"	3/4" -16	23	50,5	24
* 001995	10	3/8"	9/16" -18	17	52	19
* 001996	10	3/8"	5/8" -18	20,5	53	22
* 001997	10	3/8"	3/4" -16	24,5	52,5	24
* 001998	10	3/8"	7/8" -14	37	58	27
* 002192	12	1/2"	3/4" -16	20	71	24
* 002193	12	1/2"	7/8" -14	27	71	27
* 002194	12	1/2"	1 1/16" -12	31	71	32
* 002387	16	5/8"	7/8" -14	31	74	27
* 002388	16	5/8"	1 1/16" -12	30	71	32
* 002557	19	3/4"	1 1/16" -12	29	89	32
* 002559	19	3/4"	1 5/16" -12	45	92	41
* 002799	25	1"	1 1/16" -12	35	90	32
* 002801	25	1"	1 5/16" -12	43,5	112	41
* 003083	31	1.1/4"	1 5/8" -12	50	116	50
* 003326	38	1.1/2"	1 7/8" -12	45	120	55
* 003461	51	2"	2 1/2" -12	55	195	70

DE ORFS HORTUM RAKORU

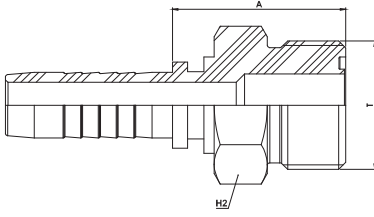

MALZEME KODU	HORTUM İÇ ÇAPI		DIŞ ÖLÇÜSÜ	BOYUTSAL ÖLÇÜLER	
	DN	İNCH	T	A	H1
001765	6	1/4"	9/16" -18	26	17
001766	6	1/4"	11/16" -16	29	19
001898	8	5/16"	11/16" -16	29	19
002079	10	3/8"	11/16" -16	27	19
002080	10	3/8"	13/16" -16	28	22
002274	12	1/2"	13/16" -16	28	22
002275	12	1/2"	1" -14	31	27
002443	16	5/8"	1" -14	34	27
002444	16	5/8"	1"3/16 -12	37	32
002634	19	3/4"	1"3/16 -12	40	32
002635	19	3/4"	1"7/16 -12	41	41
002888	25	1"	1"7/16 -12	41	41
002889	25	1"	1"11/16 -12	42,5	46
003156	31	1.1/4"	1"11/16 -12	44,5	46

DS ORFS HORTUM RAKORU

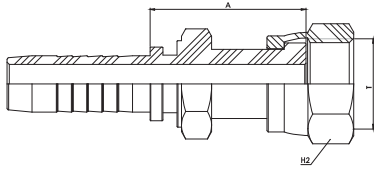

MALZEME KODU	HORTUM İÇ ÇAPI		DIŞ ÖLÇÜSÜ	BOYUTSAL ÖLÇÜLER		
	DN	İNCH	T	A	H1	H2
* 001651	6	1/4"	9/16" -18	29	14	19
* 001652	6	1/4"	11/16" -16	29	19	22
* 001818	8	5/16"	11/16" -16	29	17	22
* 001962	10	3/8"	11/16" -16	28	17	22
* 001963	10	3/8"	13/16" -16	35,5	22	24
* 002160	12	1/2"	13/16" -16	36	22	24
* 002161	12	1/2"	1" -14	37	24	30
* 002367	16	5/8"	1" -14	37,5	24	30
* 002368	16	5/8"	1"3/16 -12	29	30	36
* 002531	19	3/4"	1"3/16 -12	33,5	30	36
* 002532	19	3/4"	1"7/16 -12	37	36	41
* 002764	25	1"	1"7/16 -12	37,5	36	41
* 002765	25	1"	1"11/16 -12	48	41	50
* 003043	31	1.1/4"	1"11/16 -12	47,5	41	50

90°S ORFS HORTUM RAKORU

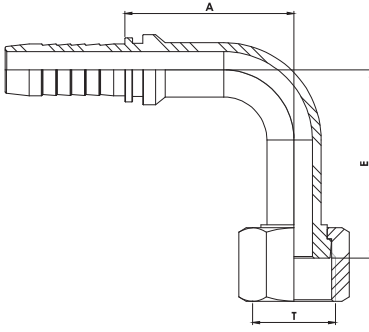

MALZEME KODU	HORTUM İÇ ÇAPı		DİŐ ÖLÇÜŐÜ	BOYUTSAL ÖLÇÜLER		
	DN	İNCH		E	A	H2
001727	6	1/4"	9/16" -18	28,5	33	19
001728	6	1/4"	11/16" -16	30	32	22
001869	8	5/16"	11/16" -16	37	38	22
002037	10	3/8"	11/16" -16	37	41	22
* 002038	10	3/8"	13/16" -16	37	41	24
* 002233	12	1/2"	13/16" -16	43	51	24
002234	12	1/2"	1" -14	53	47,5	30
002414	16	5/8"	1" -14	59	53	30
002415	16	5/8"	1"3/16 -12	51	62	36
002599	19	3/4"	1"3/16 -12	57	61	36
002600	19	3/4"	1"7/16 -12	61	72,5	41
* 002850	25	1"	1"7/16 -12	72	82	41
* 002851	25	1"	1"11/16 -12	80	79	50
* 003125	31	1.1/4"	1"11/16 -12	92	84,5	50

45°S ORFS HORTUM RAKORU

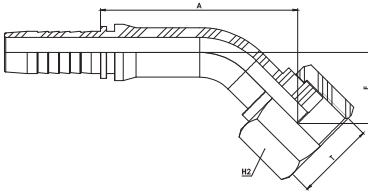

MALZEME KODU	HORTUM İÇ ÇAPı		DİŐ ÖLÇÜŐÜ	BOYUTSAL ÖLÇÜLER		
	DN	İNCH		E	A	H2
001692	6	1/4"	9/16" -18	17	45,5	19
001693	6	1/4"	11/16" -16	17	46	22
001843	8	5/16"	11/16" -16	21	53	22
002000	10	3/8"	11/16" -16	20	55	22
* 002001	10	3/8"	13/16" -16	21	57	24
* 002196	12	1/2"	13/16" -16	25	65	24
002197	12	1/2"	1" -14	25	65	30
002390	16	5/8"	1" -14	27	78	30
002391	16	5/8"	1"3/16 -12	27	78	36
002561	19	3/4"	1"3/16 -12	30	90	36
002562	19	3/4"	1"7/16 -12	33	91,5	41
* 002804	25	1"	1"7/16 -12	34	111	41
* 002805	25	1"	1"11/16 -12	50	118	50
* 003086	31	1.1/4"	1"11/16 -12	47	122	50

3000 SERİSİ DF HORTUM RAKORU

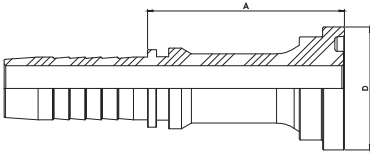

MALZEME KODU	HORTUM İÇ ÇAPI		BOYUTSAL ÖLÇÜLER		
	DN	İNCH	FLANŞ	A	D
002283	12	1/2"	1/2"	45	30,2
002284	12	1/2"	3/4"	48	38,1
002454	16	5/8"	3/4"	53,5	38,1
002644	19	3/4"	3/4"	61	38,1
002645	19	3/4"	1"	65	44,4
002905	25	1"	3/4"	53	38,1
002906	25	1"	1"	68	44,4
002907	25	1"	1.1/4"	70	50,8
002908	25	1"	1.1/2"	72,5	60,3
003171	31	1.1/4"	1"	68,5	44,4
003172	31	1.1/4"	1.1/4"	71	50,8
003173	31	1.1/4"	1.1/2"	88	60,3
003382	38	1.1/2"	1.1/2"	84	60,3
003383	38	1.1/2"	2"	84,5	71,4
003482	51	2"	2"	88	71,4
003483	51	2"	2.1/2"	88	84,1

3000 SERİSİ 90° F HORTUM RAKORU

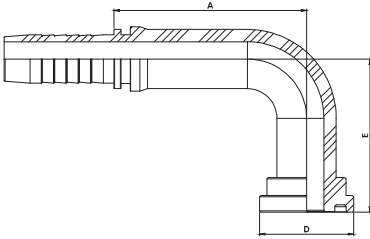

MALZEME KODU	HORTUM İÇ ÇAPI		BOYUTSAL ÖLÇÜLER			
	DN	İNCH	FLANŞ	E	A	D
002300	12	1/2"	1/2"	49	55,5	30,2
002301	12	1/2"	3/4"	51	55	38,1
002465	16	5/8"	3/4"	58	60	38,1
002674	19	3/4"	3/4"	62	78	38,1
002675	19	3/4"	1"	60	74	44,4
002951	25	1"	3/4"	80	77	38,1
002952	25	1"	1"	64	89	44,4
002953	25	1"	1.1/4"	66	90	50,8
002954	25	1"	1.1/2"	79	71	60,3
003227	31	1.1/4"	1"	88	95,5	44,4
003228	31	1.1/4"	1.1/4"	72	107	50,8
003229	31	1.1/4"	1.1/2"	85	99	60,3
003420	38	1.1/2"	1.1/2"	84	100	60,3
003421	38	1.1/2"	2"	82	103	71,4
003510	51	2"	2"	120	137	71,4
003511	51	2"	2.1/2"	120	130	84

3000 SERİSİ 45° HORTUM RAKORU

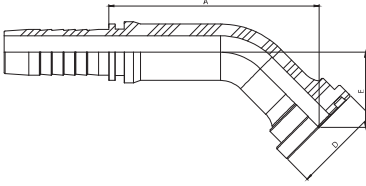

MALZEME KODU	HORTUM İÇ ÇAPI		BOYUTSAL ÖLÇÜLER			
	DN	İNCH	FLANŞ	E	A	D
002290	12	1/2"	1/2"	26,5	64	30,2
002291	12	1/2"	3/4"	24,5	71	38,1
002459	16	5/8"	3/4"	30	81	38,1
002653	19	3/4"	3/4"	32	89,5	38,1
002654	19	3/4"	1"	26	89	44,4
002925	25	1"	3/4"	38	45	38,1
002926	25	1"	1"	27,5	115,5	44,4
002927	25	1"	1.1/4"	49,5	110	50,8
002928	25	1"	1.1/2"	48,5	105	60,3
003195	31	1.1/4"	1"	46	122	44,4
003196	31	1.1/4"	1.1/4"	48	121	50,8
003197	31	1.1/4"	1.1/2"	38	130	60,3
003396	38	1.1/2"	1.1/2"	46	124	60,3
003397	38	1.1/2"	2"	43	124	71,4
003492	51	2"	2"	53	115	71,4
003493	51	2"	2.1/2"	53	100	84

6000 SERİSİ DF HORTUM RAKORU

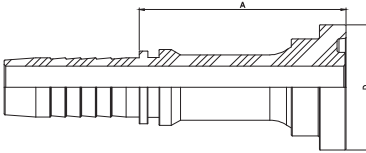

MALZEME KODU	HORTUM İÇ ÇAPI		HORTUM İÇ ÇAPI		
	DN	İNCH	FLANŞ	A	D
002287	12	1/2"	1/2"	54,5	32
002286	12	1/2"	5/8"	71	34,1
002288	12	1/2"	3/4"	65	41,3
002456	16	5/8"	1/2"	58	32
002455	16	5/8"	5/8"	58	34,1
002457	16	5/8"	3/4"	55	41,3
002647	19	3/4"	3/4"	68	41,3
002648	19	3/4"	1"	64,5	47,6
002910	25	1"	3/4"	68	41,3
002911	25	1"	1"	70	47,6
002912	25	1"	1.1/4"	81	54
003175	31	1.1/4"	1"	78,5	47,6
003176	31	1.1/4"	1.1/4"	87	54

6000 SERİSİ 90°F HORTUM RAKORU

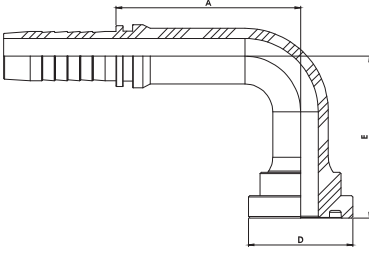

MALZEME KODU	HORTUM İÇ ÇAPI		BOYUTSAL ÖLÇÜLER			
	DN	İNCH	FLANŞ	E	A	D
002304	12	1/2"	1/2"	48	55	32
002303	12	1/2"	5/8"	52	54	34,1
002305	12	1/2"	3/4"	59	49	41,3
002468	16	5/8"	1/2"	56	62,5	32
002467	16	5/8"	5/8"	56	63	34,1
002469	16	5/8"	3/4"	58,5	60	41,3
002678	19	3/4"	3/4"	64	73	41,3
002679	19	3/4"	1"	62,5	70	47,6
002956	25	1"	3/4"	85	70	41,3
002957	25	1"	1"	70	81	47,6
002958	25	1"	1.1/4"	68	85	54
003231	31	1.1/4"	1"	81,5	98	47,6
003232	31	1.1/4"	1.1/4"	76	100	54

6000 SERİSİ 45°F HORTUM RAKORU

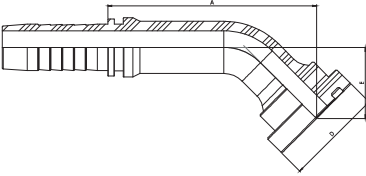

MALZEME KODU	HORTUM İÇ ÇAPI		BOYUTSAL ÖLÇÜLER			
	DN	İNCH	FLANŞ	E	A	D
002293	12	1/2"	1/2"	26	71	32
002292	12	1/2"	5/8"	33	66	34,1
002294	12	1/2"	3/4"	30	67	41,3
002462	16	5/8"	1/2"	36	71	32
002461	16	5/8"	5/8"	36	84	34,1
002463	16	5/8"	3/4"	32	82	41,3
002656	19	3/4"	3/4"	30	88	41,3
002657	19	3/4"	1"	30	88	47,6
002930	25	1"	3/4"	35	100	41,3
002931	25	1"	1"	34	108	47,6
002932	25	1"	1.1/4"	36	100	54
003198	31	1.1/4"	1"	42	110	47,6
003199	31	1.1/4"	1.1/4"	43	120	54

6000 SERİSİ DF KALIN FLANŞLI HORTUM RAKORU

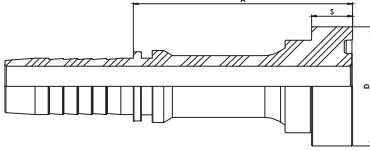

MALZEME KODU	HORTUM İÇ ÇAPI		BOYUTSAL ÖLÇÜLER			
	DN	İNCH	FLANŞ	A	D	S
002650	19	3/4"	3/4"	75	41,3	14,2
002651	19	3/4"	1"	75	47,6	14,2
002914	25	1"	3/4"	65,5	41,3	14,2
002915	25	1"	1"	69	47,6	14,2
002916	25	1"	1.1/4"	78,5	54	14,2
003178	31	1.1/4"	1"	82	47,6	14,2
003179	31	1.1/4"	1.1/4"	87,5	54	14,2
003180	31	1.1/4"	1.1/2"	88,5	63,5	14,2
003388	31	1.1/2"	1.1/2"	83,5	63,5	14,2
003486	51	2"	2"	88	80	14,2

6000 SERİSİ 45F KALIN FLANŞLI HORTUM RAKORU

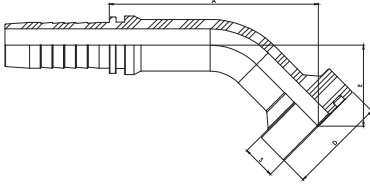

MALZEME KODU	HORTUM İÇ ÇAPI		BOYUTSAL ÖLÇÜLER				
	DN	İNCH	FLANŞ	A	E	D	S
002659	19	3/4"	3/4"	89	34,5	41,3	14,2
002660	19	3/4"	1"	85	35	47,6	14,2
002934	25	1"	3/4"	98	37	41,3	14,2
002935	25	1"	1"	95	38	47,6	14,2
002936	25	1"	1.1/4"	110	36	54	14,2
003201	31	1.1/4"	1"	102	43	47,6	14,2
003202	31	1.1/4"	1.1/4"	120	48	54	14,2
003203	31	1.1/4"	1.1/2"	125	40	63,5	14,2
003401	31	1.1/2"	1.1/2"	120	44	63,5	14,2
003496	51	2"	2"	157	53	80	14,2

6000 SERİSİ 90F KALIN FLANŞLI HORTUM RAKORU

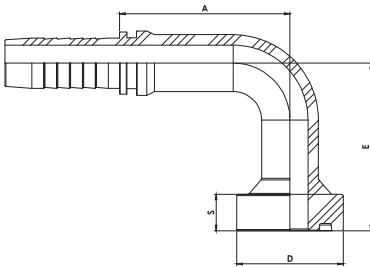

MALZEME KODU	HORTUM İÇ ÇAPI		BOYUTSAL ÖLÇÜLER				
	DN	İNCH	FLANŞ	A	E	D	S
002681	19	3/4"	3/4"	66	65	41,3	14,2
002682	19	3/4"	1"	65	65	47,6	14,2
002960	25	1"	3/4"	77	74	41,3	14,2
002961	25	1"	1"	81	73	47,6	14,2
002962	25	1"	1.1/4"	82	72	54	14,2
003234	31	1.1/4"	1"	95	80	47,6	14,2
003235	31	1.1/4"	1.1/4"	97,5	81,5	54	14,2
003236	31	1.1/4"	1.1/2"	97,5	77,5	63,5	14,2
003426	31	1.1/2"	1.1/2"	96	91	63,5	14,2
003514	51	2"	2"	139	115	80	14,2

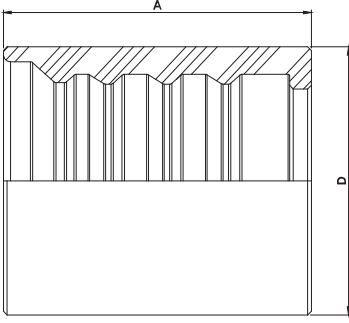

MALZEME KODU	MALZEME TANIMI	İNCH	A	D
003559	100-04 1/4" SOYMALI TİP SOKET	1/4"	27	20
003560	100-05 5/16" SOYMALI TİP SOKET	5/16"	28	22
003561	100-06 3/8" SOYMALI TİP SOKET	3/8"	30	25
003562	100-08 1/2" SOYMALI TİP SOKET	1/2"	34	28
003563	100-10 5/8" SOYMALI TİP SOKET	5/8"	37	30
003564	100-12 3/4" SOYMALI TİP SOKET	3/4"	44	36
003565	100-16 1" SOYMALI TİP SOKET	1"	54	42
003566	100-20 1 1/4" SOYMALI TİP SOKET	1.1/4"	59	50,5
003567	100-24 1 1/2" SOYMALI TİP SOKET	1.1/2"	70	57
003568	100-32 2" SOYMALI TİP SOKET	2"	72	70
003569	100-40 2 1/2 " SOYMALI TİP SOKET	2.1/2"	70	83

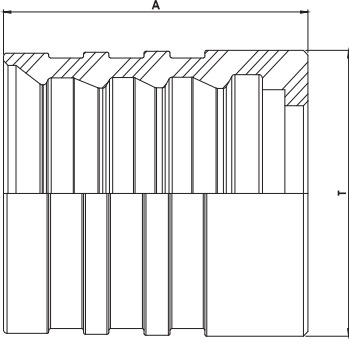

MALZEME KODU	MALZEME TANIMI	İNCH	A	D
003571	200-04 1/4" SOYMALI TİP SOKET	1/4"	30	22
003572	200-05 5/16" SOYMALI TİP SOKET	5/16"	31	24
003573	200-06 3/8" SOYMALI TİP SOKET	3/8"	33	26
003574	200-08 1/2" SOYMALI TİP SOKET	1/2"	34	30
003575	200-10 5/8" SOYMALI TİP SOKET	5/8"	39	33
003576	200-12 3/4" SOYMALI TİP SOKET	3/4"	40	38
003577	200-16 1" SOYMALI TİP SOKET	1"	54	46
003578	200-20 1 1/4" SOYMALI TİP SOKET	1.1/4"	60	57
003579	200-24 1 1/2" SOYMALI TİP SOKET	1.1/2"	70	65
003580	200-32 2" SOYMALI TİP SOKET	2"	72	79

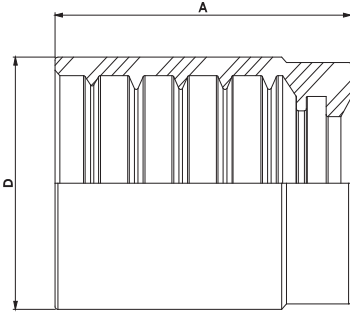

MALZEME KODU	MALZEME TANIMI	İNCH	A	D
003633	5000-03 3/16" SOYMASIZ TİP SOKET	3/16"	23	21
003634	5000-04 1/4" SOYMASIZ TİP SOKET	1/4"	30,2	23
003635	5000-05 5/16" SOYMASIZ TİP SOKET	5/16"	30	24
003636	5000-06 3/8" SOYMASIZ TİP SOKET	3/8"	31,3	26
003637	5000-08 1/2" SOYMASIZ TİP SOKET	1/2"	34,25	29
003638	5000-10 5/8" SOYMASIZ TİP SOKET	5/8"	37	33
003639	5000-12 3/4" SOYMASIZ TİP SOKET	3/4"	42,4	37
003640	5000-16 1" SOYMASIZ TİP SOKET	1"	51,4	46
003641	5000-20 1 1/4" SOYMASIZ TİP SOKET	1.1/4"	57,2	59
003642	5000-24 1 1/2" SOYMASIZ TİP SOKET	1.1/2"	67	67
003643	5000-32 2" SOYMASIZ TİP SOKET	2"	72	80
003644	5000-40 2 1/2" SOYMASIZ TİP SOKET	2.1/2"	69	88,9

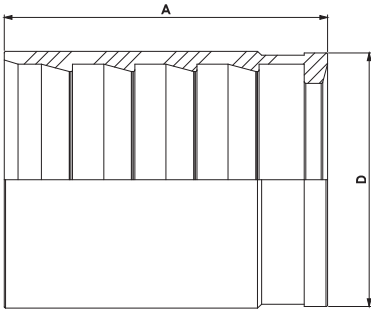

MALZEME KODU	MALZEME TANIMI	İNCH	A	D
003590	400-03 3/16" SOKET	3/16"	26,35	14
003591	400-04 1/4" SOKET	1/4"	30,2	18
003592	400-05 5/16" SOKET	5/16"	32	19
003593	400-06 3/8" SOKET	3/8"	33	22
003594	400-08 1/2" SOKET	1/2"	33,75	26
003595	400-10 5/8" SOKET	5/8"	35,9	29
003596	400-12 3/4" SOKET	3/4"	41,6	33
003597	400-16 1" SOKET	1"	49,7	41
003598	400-20 1 1/4" SOKET	1.1/4"	57	48,25

MALZEME KODU	MALZEME TANIMI	İNCH	A	D
003602	2100-10 5/8" INTERLOCK TİP İÇTEN KİLİTLEMELİ SOKET (M01300 MUADİLİ)	5/8"	39	33
003603	2100-12 3/4" INTERLOCK TİP İÇTEN KİLİTLEMELİ SOKET (M01300 MUADİLİ)	3/4"	53	40
003604	2100-16 1" INTERLOCK TİP İÇTEN KİLİTLEMELİ SOKET (M01300 MUADİLİ)	1"	66	49
003605	2100-20 1 1/4" INTERLOCK TİP İÇTEN KİLİTLEMELİ SOKET (M01300 MUADİLİ)	1.1/4"	88,5	60
003606	2100-24 1 1/2" INTERLOCK TİP İÇTEN KİLİTLEMELİ SOKET (M01300 MUADİLİ)	1.1/2"	102	69,4
003607	2100-32 2" INTERLOCK TİP İÇTEN KİLİTLEMELİ SOKET (M01300 MUADİLİ)	2"	108	86,5

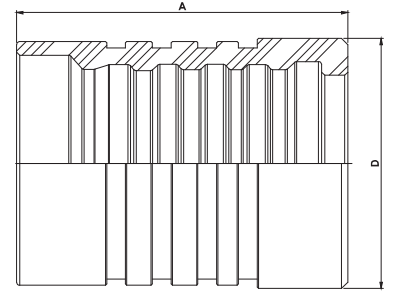

MALZEME KODU	MALZEME TANIMI	İNCH	A	D
003608	2200-20 1 1/4" INTERLOCK TİP İÇTEN KİLİTLEMELİ SOKET (M01400 MUADİLİ)	1.1/4"	88	57
003609	2200-24 1 1/2" INTERLOCK TİP İÇTEN KİLİTLEMELİ SOKET (M01400 MUADİLİ)	1.1/2"	102	64,3
003610	2200-32 2" INTERLOCK TİP İÇTEN KİLİTLEMELİ SOKET (M01400 MUADİLİ)	2"	108	86,5

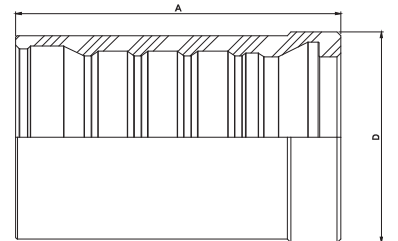

MALZEME KODU	MALZEME TANIMI	İNCH	A	D
003611	2500-10 5/8" SOKET İTERLOCK PLUS TİP - 4KATLI HORTUMLAR İÇİN (M01500 MUADİLİ)	5/8"	41	35
003612	2500-12 3/4" SOKET İTERLOCK PLUS TİP - 4KATLI HORTUMLAR İÇİN (M01500 MUADİLİ)	3/4"	51,5	40
003613	2500-16 1" SOKET İTERLOCK PLUS TİP - 4KATLI HORTUMLAR İÇİN (M01500 MUADİLİ)	1"	64,5	48
003614	2500-20 1 1/4" SOKET İTERLOCK PLUS TİP - 4KATLI HORTUMLAR İÇİN (M01500 MUADİLİ)	1.1/4"	83,8	56,95

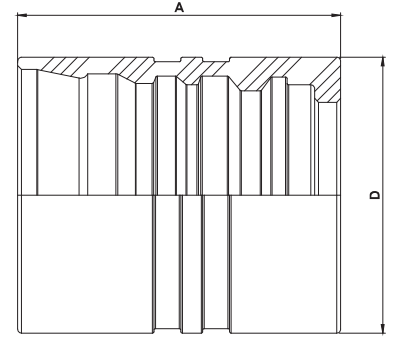

MALZEME KODU	MALZEME TANIMI	İNCH	A	D
003624	3100-20 1 1/4" XTRALOCK TİP İÇTEN KİLİTLEMELİ SOKET (M01800 MUADİLİ)	1.1/4"	88,2	65
003626	3100-32 2" XTRALOCK TİP İÇTEN KİLİTLEMELİ SOKET (M01800 MUADİLİ)	2"	108,2	86,6
003627	3100-40 2 1/2 " XTRALOCK TİP İÇTEN KİLİTLEMELİ SOKET (M01800 MUADİLİ)	2.1/2"	135	103
003628	3100-48 3" XTRALOCK TİP İÇTEN KİLİTLEMELİ SOKET (M01800 MUADİLİ)	3"	125	113,3

